

# Data Sheet



Article number: 339703250000

Description: Multibeam 6 Coupling 703.25.0000  
St. steel & clamp hubs

## Measures

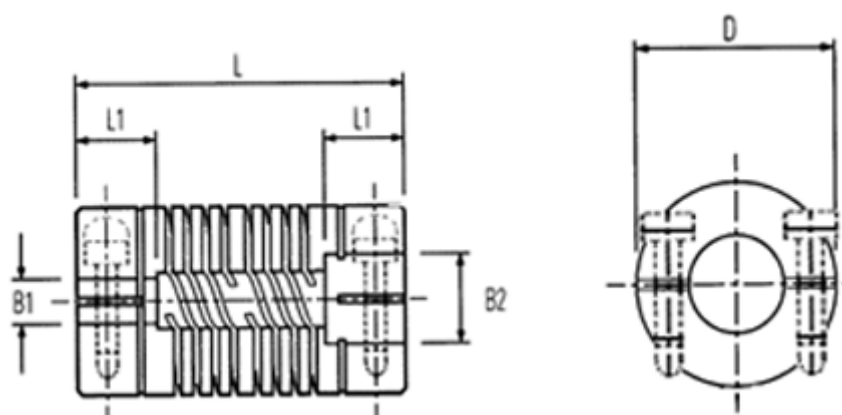

B2: Pre-drilled	= 5.0
B2: Pre-drilled	= 8.00
Cap screw	= M3
D	= 25.4
L	= 38.1
L1	= 11.0
Max angular displacement	= 0.38
Max B1 & B2	= 12.70

Max parallel displacement	= 7
Peak Torque NM	= 16.00